

BSS138-G

N-Channel 50-V(D-S) MOSFET
RoHS Device

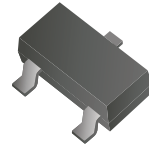

Features

- High density cell design for extremely low $R_{DS(ON)}$.
- Rugged and Reliable.

Mechanical data

- Case: SOT-23, molded plastic.
- Terminals: solderable per MIL-STD-750, method 2026.

Circuit diagram

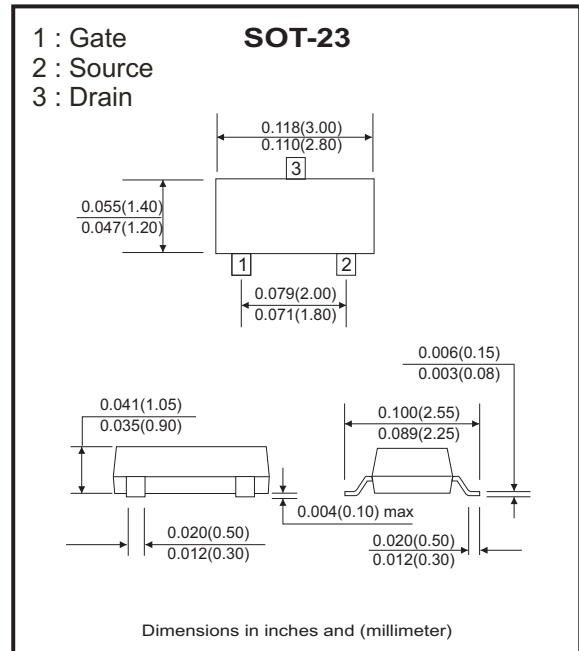
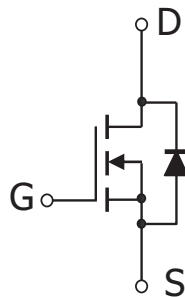

Maximum Ratings (at $T_a=25^\circ\text{C}$ unless otherwise noted)

Parameter	Symbol	Value	Units
Drain-source voltage	V_{DS}	50	V
Continuous gate-source voltage	V_{GS}	± 20	V
Continuous drain current	I_D	0.22	A
Power dissipation	P_D	0.35	W
Thermal resistance from Junction to ambient	$R_{\theta JA}$	357	$^\circ\text{C/W}$
Operating temperature	T_J	150	$^\circ\text{C}$
Storage temperature	T_{STG}	-55 to +150	$^\circ\text{C}$

Company reserves the right to improve product design , functions and reliability without notice.

Electrical Characteristics (TA=25°C unless otherwise noted)

Parameter	Conditions	Symbol	Min	Typ	Max	Unit
Off characteristics						
Drain-Source breakdown voltage	$V_{GS}=0V, I_D=250\mu A$	$V_{(BR)DSS}$	50			V
Gate-body leakage	$V_{DS}=0V, V_{GS}=\pm 20V$	I_{GSS}			± 100	nA
Zero gate voltage drain current	$V_{DS}=50V, V_{GS}=0V$	I_{DSS}			0.5	μA
	$V_{DS}=30V, V_{GS}=0V$	I_{DSS}			100	nA
On characteristics						
Gate-threshold voltage (note 1)	$V_{DS}=V_{GS}, I_D=1mA$	$V_{GS(th)}$	0.8		1.5	V
Static drain-source on-resistance (note 1)	$V_{GS}=10V, I_D=0.22A$	$R_{DS(ON)}$			3.5	Ω
	$V_{GS}=4.5V, I_D=0.22A$				6	
Forward transconductance (note 1)	$V_{DS}=10V, I_D=0.22A$	g_{FS}	0.12			S
Dynamic characteristics (note 2)						
Input capacitance	$V_{DS}=25V, V_{GS}=0V, f=1MHz$	C_{iss}		27		pF
Output capacitance		C_{oss}		13		
Reverse transfer capacitance		C_{rss}		6		
Switching Characteristics						
Turn-on delay time (note 1,2)	$V_{DD}=30V, V_{DS}=10V, I_D=0.29A, R_{GEN}=6\Omega$	$t_{d(on)}$			5	ns
Rise time (note 1,2)		t_r			18	
Turn-off delay time (note 1,2)		$t_{d(off)}$			36	
Fall time (note 1,2)		t_f			14	
Drain-source body diode characteristics						
Body diode forward voltage (note 1)	$I_S=0.44A, V_{GS}=0V$	V_{SD}			1.4	V

Note:

1. Pulse test ; Pulse width $\leq 300\mu s$, Duty cycle $\leq 2\%$
2. These parameters have no way to verify.

Company reserves the right to improve product design , functions and reliability without notice.

RATING AND CHARACTERISTIC CURVES (BSS138-G)

Fig.1 - Output Characteristics

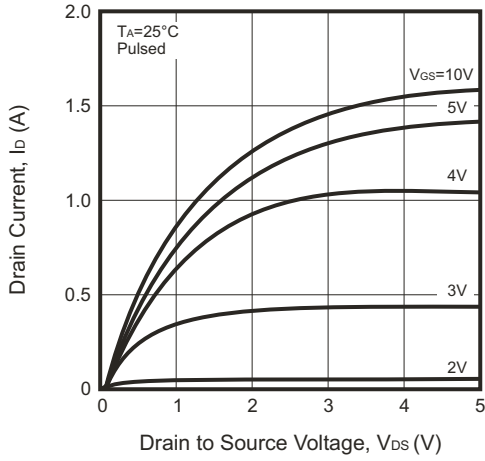

Fig.2 - Transfer Characteristics

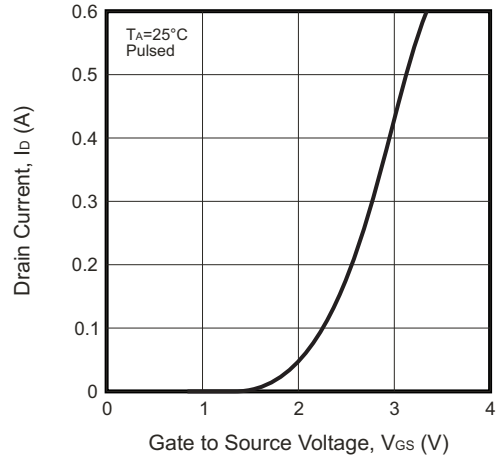

Fig.3 - $R_{DS(ON)}$ - I_D

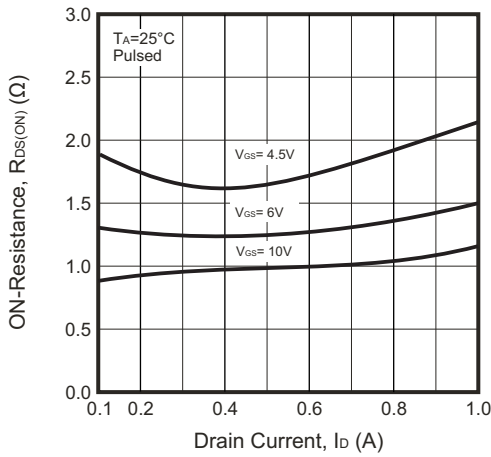

Fig.4 - $R_{DS(ON)}$ - V_{GS}

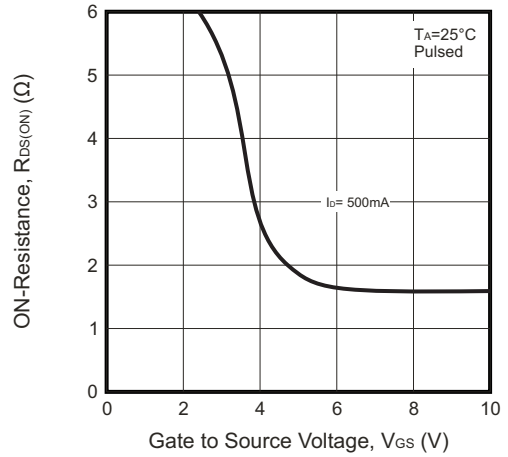
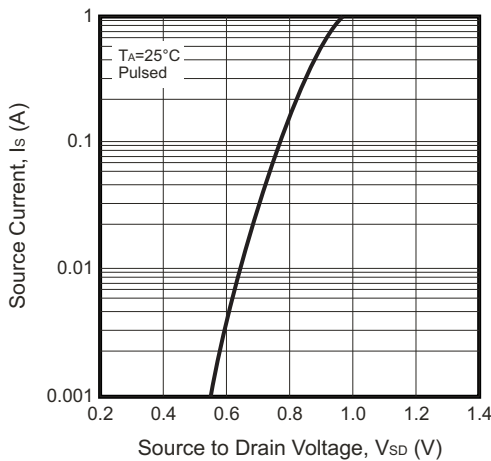
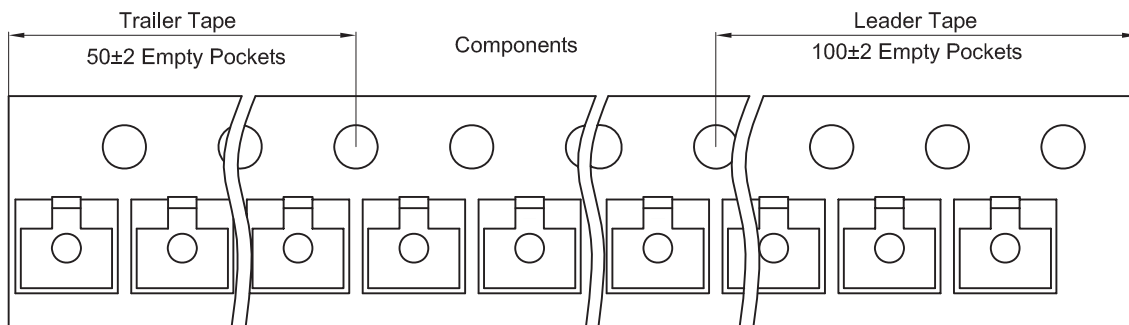
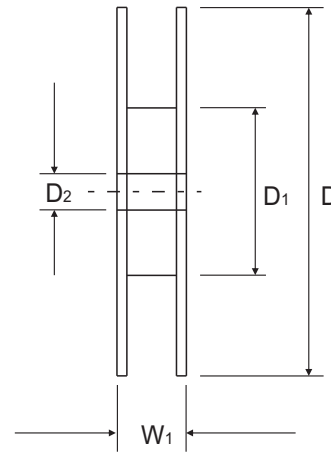
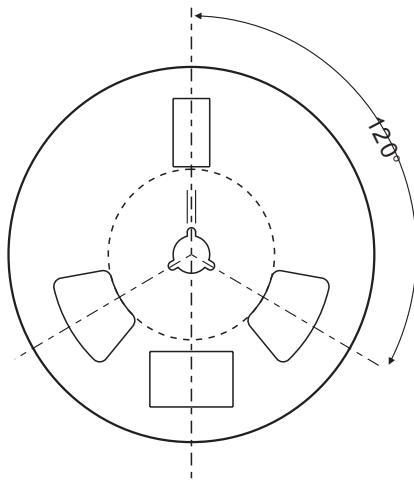
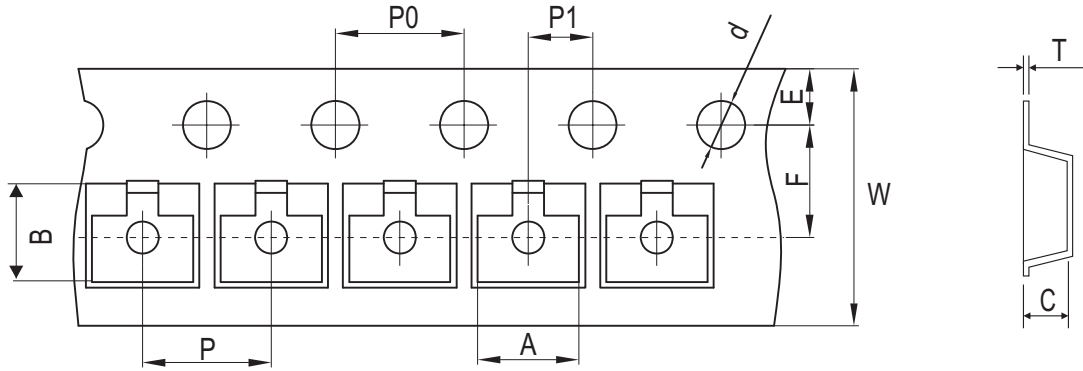

Fig.5 - I_S - V_{SD}



Reel Taping Specification



SOT-23	SYMBOL	A	B	C	d	D	D1	D2
	(mm)	3.15 ± 0.10	2.77 ± 0.10	1.22 ± 0.10	Φ1.50 ± 0.10	178 ± 2.00	54.40 ± 1.00	13.00 ± 1.00
	(inch)	0.124 ± 0.004	0.109 ± 0.004	0.048 ± 0.004	Φ0.059 ± 0.004	7.008 ± 0.079	2.142 ± 0.039	0.512 ± 0.039

SOT-23	SYMBOL	E	F	P	P0	P1	W	W1
	(mm)	1.75 ± 0.10	3.50 ± 0.10	4.00 ± 0.10	4.00 ± 0.10	2.00 ± 0.10	8.00 + 0.30 / - 0.10	12.30 ± 1.00
	(inch)	0.069 ± 0.004	0.138 ± 0.004	0.157 ± 0.004	0.157 ± 0.004	0.079 ± 0.004	0.315 + 0.012 / - 0.004	0.484 ± 0.039

Marking Code

Part Number	Marking Code
BSS138-G	SS

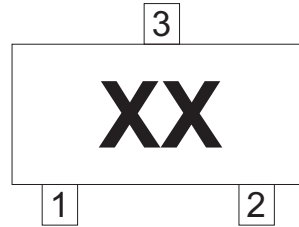

xx = Product type marking code

Suggested PAD Layout

SIZE	SOT-23	
	(mm)	(inch)
A	0.80	0.031
B	1.90	0.075
C	2.02	0.080
D	2.82	0.111

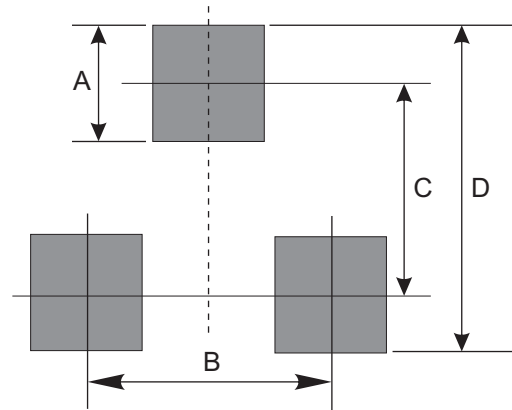

Standard Packaging

Case Type	REEL PACK	
	REEL (pcs)	Reel Size (inch)
SOT-23	3,000	7